

it Istruzioni di installazione
en Installation instructions
fr Instruction de installation

Centralina rivelazione fughe gas
 Gas leak detection system
 Système de détection de fuite de gaz

Sensigas®
UCE18

en English

These instructions must be kept together with the device.



General Information

The installation, the periodical inspections, or the devices replacement must be done by qualified technicians.

The installation of a gas leak detection system for methane or liquid petroleum gas (LPG), do not exempt from the compliance to the safety rules and to all the laws in force concerning the installation and the use of gas-operating-devices, for the ventilation of the rooms and for the discharge of flue gases.

Installation

Mounting position

Check that environmental specifications of the installation place are compatible with the values listed on Technical Data.

Control Unit UCE18

- A on DIN bar (EN50022-35 x 7.5) min length 170mm
- B on wall, with 2 screws
- C on panel front end using a DIN bar length 195mm, n°2 50mm spacers, screws and washers

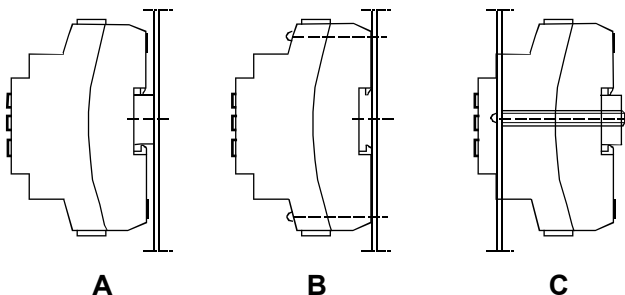

Sensors UR.13/A

- On wall in an area subject to natural air circulation.
- Never close to water jets, suction grids, windows, openings, etc.
- At a suitable distance from gas devices in order to avoid unexpected system actions due to functional losses.
- In an accessible position for controls and inspections.

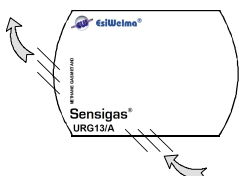

Respect the correct mount orientation in order to ensure the normal convection air flow inside the sensor.

- URG13/A:** High, 20...30cm from the ceiling, to detect light gases like methane, etc.
- URG13.P/A:** Low, 20...30cm from the floor, to detect heavy gases like LPG, propane, butane etc.
- URO13/A:** At about 1,5m from the floor, to detect carbon monoxide (CO)



NOTE for sensor installation

In case of a new plant the sensors should be installed as latest as possible so that typical working-place activities (particularly welding, painting, etc.) cannot damage the sensors (particularly their sensing element). In any case the installation must be completed before gas devices and gas appliances are activated.

Wiring

Common electric cables can be used. However, when installing in places subject to high electromagnetic interference, use of shielded cables is recommended.

The UCE18 must be **permanently** powered at 24VAC.



There is no protection against accidental connection with 230V on the 24V side.

Use double insulation safety transformers; they should be sized for continuous operation at rated power (refer to Technical Data).

- Comply with all current regulations for wiring
- Connections must be done in accordance with the diagrams reported in the following operating instructions
- Conform to indicated cable length and cross section
- Connect only valves at 12VDC with power not greater than 13W each (total max 26W) to EV output
- Internal relays with positive logic operation that is always energized contact in case of alarm or fault absence.



Never touch for any reason the sensing element or electronic circuit. Any tampering might compromise the correct system operation.

Commissioning

UCE18 does not require any programming or parameterization.

- Check that sensors are suitable for the gas type to be detected:
 - URG13/A = Methane sensor
 - URG13.P/A = LPG sensor
 - URO13/A = Carbon Monoxide (CO) sensor
- Check that power absorbed by any devices connected to relay terminals is lower than or equal to contacts maximum ratings (please refer to Technical Data).
- Make certain that termination resistors R=18Kohm 1/4W, factory supplied, are disconnected from used sensor inputs, while they must be connected to any unused sensor inputs (terminals C-S).
- If no valve should be connected to EV output, insert a valve termination Rv 1.8Kohm 1/2W (factory supplied) in the EV terminal. This will avoid any wrong valve fault signal.

Jumper Setup

- Set jumper JP2 VALVE TYPE to NC for normally closed valve type (deliver condition) or to NO for normally open valve type.
- Set jumper JP3 VALVE MODE only if normally open valve is used. CONT position allows to set EV output constantly powered in case of gas alarm, while PULSE position allows to set it powered by impulses at 10s intervals.

Jumper for valve type selection

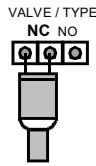

Jumper for valve mode selection

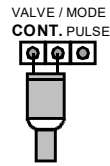

NOTE: EACH CHANGE OF JUMPER SETUP MUST BE MADE UNDER POWER OFF.

Button functions

- OUTPUT TEST button: if pressed for at least 5s, starting from normal operating condition, temporarily activates all outputs (valve + relay + hooter) in order to check regular operation of intervention and signal devices.

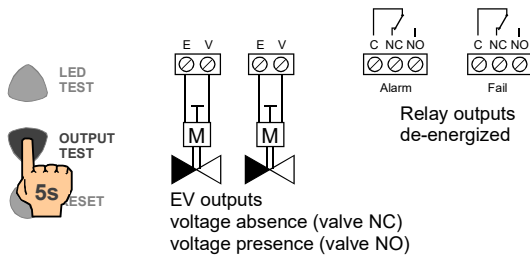

Note: relay operation in positive logic

Energized relay = alarm / fault absence

De-energized relay = alarm / fault presence

- LED TEST button: temporarily turns all LEDs ON in order to check their integrity.

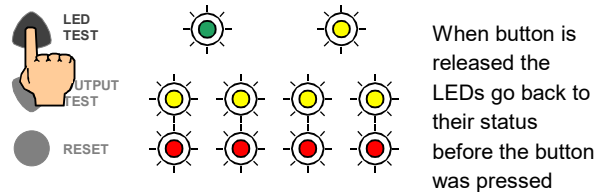

Operation

When the UCE18 is powered at 24VAC **preheating phase** starts up (about 1 min) while LEDs will indicate:

- Green LED flashing (frequency 1Hz)
- Control Unit Yellow LED steady on
- Sensor Yellow LEDs steady on
- Red LEDs steady on

During this phase there is no voltage at EV terminals, so it is not possible to energize the solenoid valve(s) if NC type, while it is possible to energize it/them if NO type. Further, the relays are not energized.

After preheating phase, the **test phase** follows (3 min) while it is possible to check sensors operation. To this purpose, all internal timings for alarm management are zeroed.

In this phase LEDs will indicate:

- Green LED flashing (frequency 2Hz)
- Control Unit yellow LED steady on
- Sensors Yellow LEDs steady on
- Red LEDs steady on

During this phase there is voltage at NC solenoid valve(s), so it is possible to open it/them using its manual actuator placed on the same valve. The relays are energized.

Connect the battery to relevant terminals paying attention to polarity.

Operation test

During normal operation it is possible to simulate an alarm, in order to check system functionality. Act as follows:

- Activate test phase (if no more active after preheating) holding down RESET button for at least 5s.
- With cover fitted on approach a gas source to a sensor grid, and let come out a small amount of gas.



CAUTION: don't spray the gas directly on the sensor, otherwise it will be permanently damaged. Act to increase gradually the gas concentration close to the sensing element.



Sensors can be permanently damaged when exposed to high or continuous concentrations of interfering substances (like fresh paint, ammonia based cleaning materials, alcoholic or silicone solvents etc).



To check carbon monoxide sensor a combustion smoke can be used.

After these operation the control unit must indicate a gas alarm status with these effects:

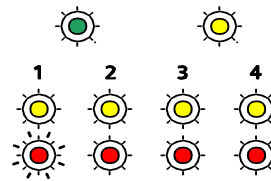

- Sensor Red LED flashing
- Solenoid valve(s) driven to closed position
- Changeover of alarm relay contact (closed contact C - NC)
- Piezoelectric hooter activated (if present)

To restore normal operation, once alarm status is over, press RESET.

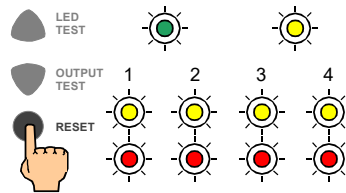

- Sensor Red LED reverts to steady on
- Alarm relay contact reverts to initial position (closed contact C - NO)
- Piezoelectric hooter deactivated (if present)

Note:

- An alarm or fault condition during test phase (3 min) causes flashing of the relevant red or yellow LEDs at 2Hz frequency instead of 1Hz as indicated in functional table. This latter will be valid for events starting from normal operating condition.
- Return to normal operating condition by pressing RESET button is possible only if there aren't any active alarms.

Open the solenoid valve(s) manually.

The control unit continuously checks connections integrity both for sensors and valves.



The sensor will perform best if used in an area where the only gas or vapor present, besides fresh air, is the gas or vapor that you wish to detect.

If used in an area contaminated with relative high concentration of different interfering substances (like fresh paint, ammonia based cleaning materials, alcoholic or silicone solvents etc.), false alarms may occur.



IMPORTANT

We recommend to repeat operating test at least once a year or after a long stop period and in any case every time that a sensor is replaced.

Technical Data

Control Unit UCE18

Power supply voltage	24VAC +/- 10%
Frequency	50/60Hz
Power consumption	32VA max (with battery under charge)
Sensor inputs	4 x UR.13/A
Control outputs	- 2 Electronic 12VDC (26W max total) - 2 SPDT Relays 250V 5(3)A
Controlled valve type	Normally Closed or Normally Open
Operation logic	positive (normally energized relays, de-energize in case of alarm / fault)

"VALVE TYPE" Jumper

Valve type	NO = Normally Open (type NC = Normally Closed
------------	--

"VALVE MODE" Jumper

Valve output mode (for NO type only)	CONT = continuous PULSE = pulses (1 pulse every 10s)
---	---

Optical signals (please refer to functional tables)

Green LED	Power presence / test
Control U. Yellow LED	Valve(s) / control unit fault
Sensors Yellow LEDs	Sensor fault
Red LEDs	Gas alarm

Sensors connection length	cable 1.5mm ² max 80m
Valve(s) connection length (one cable per valve)	cable 1.5mm ² max 80m cable 1.5mm ² max 40m (2 x 13W)
Battery protection fuse	T3.15A 250V 5x20
Dimensions	174 x 106 x 56.5 mm
Protection	IP20 – EN60529
Room temperature	0...50°C
Room humidity	Max 90% R.H. non condensing

Sensors UR.13/A

Sensing element	Tin dioxide semiconductor
Intervention threshold	
URG13/A	20% LEL methane (10000ppm)
URG13.P/A	20% LEL LPG (3720ppm)
URO13/A	200 ppm CO
Protection	IP44 (if correctly installed)
Average life time	5 years from installation date
Room temperature	0...50°C
Room humidity	Max 90% R.H. non condensing

Built-in relay

Operation	Positive logic (normally energized). de-energizes in case of alarm / fault
Changeover contact	Voltage free 250V 5(3)A

Built-in battery charger

Charge voltage	13.8VDC
Charge current	0.5A max
Battery	12V 6+10 Ah (not supplied) Automatic intervention and current limit

CE Conformity

Regulations	Low Voltage	2014/35/UE
	Electromagnetic Compatibility	2014/30/UE
Standards	EN50194	
	EN50270	



CAUTION

Lifetime of sensors URG13/A, URG13.P/A e URO13/A is 5 years from installation date. It is necessary to substitute them systematically before the end of the 5th year of use.

Average lifetime of sensors has been calculated considering a typical usage in an environment free of pollution substances (gases, solvents, etc.). A frequent presence or high concentration of these substances may accelerate normal oxidation process of the sensing element and consequently shorten its decay time (lifetime).

Functional tables

LEDs status Functions				
	Green LED	Control U. yellow LED	Sensor yellow LED	Sensor red LEDs
Sensors preheating (1min)	Flash 1Hz	ON	ON	ON
TEST phase (3 min)	Flash 2Hz	ON	ON	ON
Normal operation	ON	ON	ON	ON
Gas alarm	ON	ON	ON	Flash 1Hz*
Valve fault	ON	Flash 1Hz	ON	ON
Sensor fault (up to 3)	ON	ON	Flash 1Hz*	OFF*
Sensor fault (all)	ON	OFF	Flash 1Hz	OFF
Ext. hooter alarm	ON	Flash 2Hz	ON	ON
General fault	ON	OFF	OFF	OFF

* for relative sensor(s) in alarm/fault

Output status Functions				
	2 EV outputs (NC valve)	Alarm relay output	Fail relay output	Hooter output
Sensors preheat.(1 min)	Voltage absence	De-energized	De-energized	Inactive
TEST phase (3 min)	Voltage presence	Energized	Energized	Inactive
Normal operation	Voltage presence	Energized	Energized	Inactive
Gas alarm	Voltage absence	De-energized	Energized	Active
Valve fault	Voltage absence	Energized	De-energized	Active
Sensor fault (up to 3)	Voltage presence	Energized	De-energized	Active
Sensor fault (all)	Voltage absence	De-energized	De-energized	Active
Ext hooter fault	Voltage presence	Energized	De-energized	Active
General fault	Voltage absence	De-energized	De-energized	Active

Simultaneousness of 2 or more events causes a combined management of LEDs and outputs in accordance with a defined priority.



IMPORTANT

IN CASE OF ALARM FOR GAS LEAK OR CARBON MONOXYDE PRESENCE ACT AS FOLLOWS:

- Cut off all free flames and all gas-supplied devices
- Do not switch-on or switch-off electrical lights or any other electrically-supplied appliance, in order to avoid the sparkling (cause of explosion for explosive gas)
- Close the main valve of gas network or of LPG gas bottle
- Open windows and doors to ventilate the rooms
- Look for the cause of alarm, and eliminate it. If you are not able to find and to eliminate the cause of the alarm, leave the building, and, from the outside, call for emergency aids.



Environmental compatibility and disposal

This product was developed and manufactured using materials and processes which take full account of environmental issues and which comply with our environmental standards.

Please note the following for disposal at the end of the product life, or in the event of its replacement:

- For disposal, this product is defined as waste from electrical and electronic equipment ("electronic waste"); do not dispose of it as household waste. This applies particularly to the PCB assembly.
- **Observe all current local laws and regulations.**
- Always aim for maximum re-use of the basic materials at minimum environmental stress. Observe any notes on materials and disposal that may be attached to individual components.
- Use local depots and waste management companies, or refer to your supplier or manufacturer to return used products or to obtain further information on environmental compatibility and waste disposal.
- The UCE18 shipping case can be recycled. Retain it for future use or in case of product return to the manufacturer

Troubleshooting

Effect	Possible cause
NC valves type do not open	<ul style="list-style-type: none"> Valve not connected No power NO valve type instead of NC type Incompatible valve type (power absorption > 26W total) Alarm not reset or current Current sensor preheating phase All sensors defective General Fault presence
(NO) valve type does not close	<ul style="list-style-type: none"> Valve not connected Sensor not in alarm condition Cable interrupted
RESET button does not restore default conditions	<ul style="list-style-type: none"> A sensor still in alarm condition Control unit fault (Control unit Yellow LED OFF)
OUTPUT Test button does not work	<ul style="list-style-type: none"> Current fault / alarm

Connections

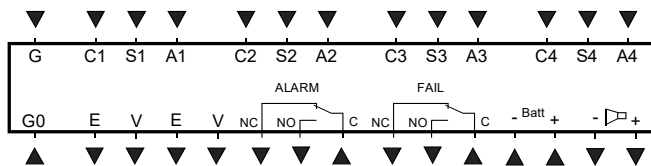

G	24 V AC power supply, voltage
G0	24 V AC power supply, system neutral
C1	Sensor input 1 (common)
S1	Sensor input 1 (signal)
A1	Sensor input 1 (power)
C2	Sensor input 2 (common)
S2	Sensor input 2 (signal)
A2	Sensor input 2 (power)
C3	Sensor input 3 (common)
S3	Sensor input 3 (signal)
A3	Sensor input 3 (power)
C4	Sensor input 4 (common)
S4	Sensor input 4 (signal)
A4	Sensor input 4 (power)
E	Valve output 12VDC
V	Valve output 12VDC
C	alarm Alarm relay output (common)
NC	alarm Alarm relay output (normally closed contact)
NO	alarm Alarm relay output (normally open contact)
C	fail Fault relay output (common)
NC	fail Fault relay output (normally closed contact)
NO	fail Fault relay output (normally open contact)
+	Batt Battery output +
-	Batt Battery output -
+	Hooter output +
-	Hooter output -

Layout

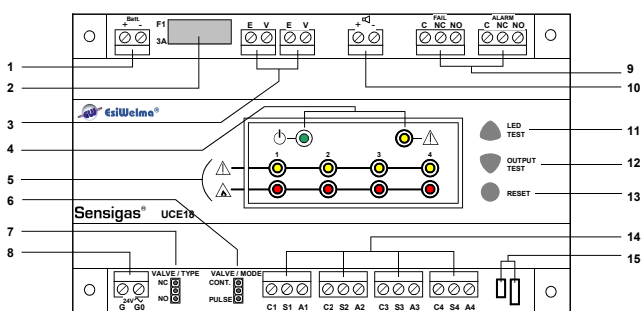

- | | | | |
|---|--------------------------------|----|-------------------------------|
| 1 | Battery connection terminal | 9 | Alarm and Fail relay outputs |
| 2 | Battery protection fuse T3.15A | 10 | 12VDC 300mA max hooter output |
| 3 | 12V valve terminals | 11 | LED Test button |
| 4 | Control Unit status LEDs | 12 | OUTPUT Test button |
| 5 | Sensors status LEDs | 13 | RESET button |
| 6 | Valve Mode Jumper | 14 | Remote sensors terminals |
| 7 | Valve Type Jumper | 15 | Not used |
| 8 | 24VAC power supply terminal | | |

 Due to our policy of continuous product improvement, specifications are subject to change without notice.

Wiring diagrams

Control unit UCE18 with 4 sensors and n.2 12VDC solenoid valves. 12V buffer battery and external hooter. Optional devices (lamps, extractors).

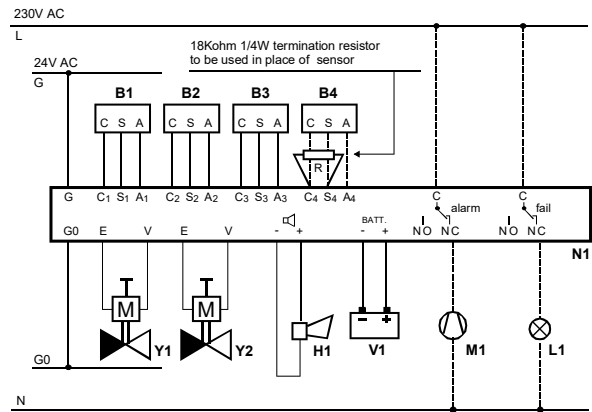

- | | |
|---------|--|
| N1 | Control unit UCE18 |
| B1 ÷ B4 | Sensors UR.13/A |
| Y1 ÷ Y2 | Solenoid valves 12VDC |
| H1 | External hooter 12VDC 300mA max |
| V1 | Battery 12V 6÷10Ah (not supplied) |
| M1 - L1 | Auxiliary devices (lamps, extractors, etc.). |

Control unit UCE18 with con 4 sensors and 230VAC solenoid valve. External hooter 12V. Control of optional auxiliary devices (signal lamps etc).

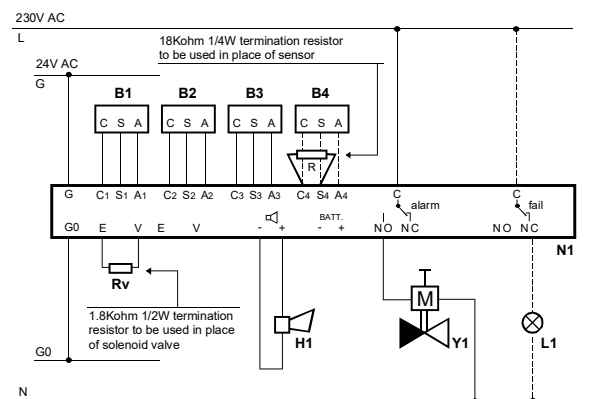

- | | | | |
|---------|---|----|------------------|
| N1 | Control unit UCE18 | Rv | Factory supplied |
| B1 ÷ B4 | Sensors UR.13/A | | |
| Y1 | Solenoid valve 230VAC | | |
| H1 | External hooter 12VDC 300mA max | | |
| L1 | Auxiliary devices (signal lamps, etc.). | | |

Dimensions

UCE18

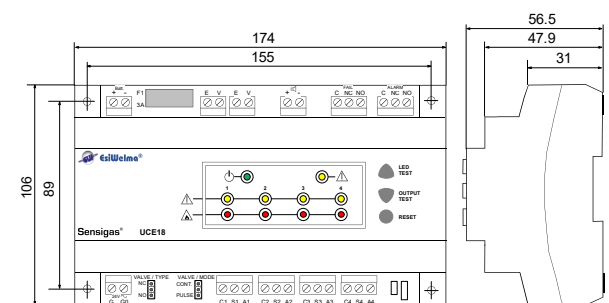

UR.13/A

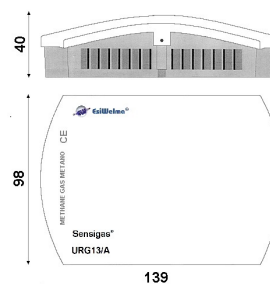

Dimensions in mm